

INSTRUCTION MANUAL

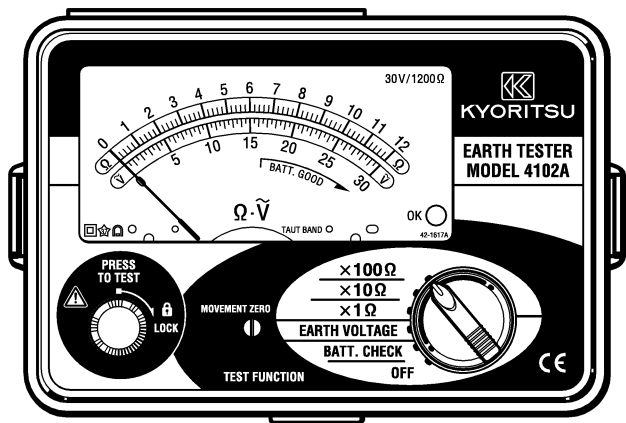

ANALOG EARTH RESISTANCE TESTER

MODEL 4102A

Contents

1. Safety Precautions	1
2. Features	3
3. Specifications	3
4. Layout Diagram	6
5. Scale Reading	7
6. Preparation for Measurement	7
6-1 Mechanical Zero Adjustment	7
6-2 Connecting Test Probe	7
6-3 Battery Voltage Check	7
7. Operating Instructions	8
7-1 Principle of Measurement	8
7-2 Precise Measurement	8
7-3 Simplified Measurement	10
8. Battery Replacement	13
9. Notes on Housing Case & Accessories	14
9-1 Case Lid	14
9-2 How to Fit Strap Belt	15
10. Cleaning of Meter Cover	15

1. Safety Precautions



- The instrument is designed, manufactured, tested and shipped in prime condition in accordance with the following standards.
 - IEC 61010-1 Overvoltage CAT III 300V Pollution Degree 2
 - IEC 61010-2-31
 - IEC 61557-1,5
 - IEC 60529 (IP54)
 - JIS C 1304-95

This instruction manual contains warnings and safety rules which must be observed by the user to ensure safety operation of the instrument and to retain it in safe condition. Therefore, read through these instructions before using the instrument.

WARNING

- Read through and understand instructions contained in this manual before using the instrument.
- Save and keep the manual handy to enable quick reference whenever necessary.
- Be sure to use the instrument only in its intended applications and to follow measurement procedures described in the manual.
- Be sure to understand and follow all safety instructions contained in the manual.

Be sure to observe the above rules strictly. Not following the instructions may cause injury or instrument damage.

- The symbol  on the instrument means that the user must refer to the manual for safe operation of the instrument. There are three kinds of the symbol . Read the instructions following each symbol carefully.

 DANGER is reserved for conditions and actions that are likely to cause serious or fatal injury.

 WARNING is reserved for conditions and actions that can cause serious or fatal injury.

 CAUTION is reserved for conditions and actions that can cause minor injury or instrument damage.

⚠ DANGER

- Make sure that the range selector switch is set to a desired position before making measurement.
- Do not make measurement in the presence of flammable gasses. Otherwise, the use of the instrument may cause sparking, which leads to an explosion.
- Never attempt to use the instrument if its surface or your hand is wet.
- Do not apply an electrical quantity exceeding the allowable limit of a measuring range.
- Never open the battery compartment cover while making measurement.

⚠ WARNING

- Never attempt to make measurement, if any abnormal conditions are noted, such as broken case, cracked test leads and exposed metal parts.
- Never turn the range selector switch with test leads connected to the equipment under test.
- Do not install substitute parts or make any decomposition or modification to the instrument. Return the instrument to Kyoritsu or your distributor for repair or re-calibration.
- Do not replace batteries when the surface of the instrument is wet.
- Always set the range switch to the OFF position before opening the battery compartment cover for battery replacement.

⚠ CAUTION

- Make sure that the test lead and the probe are securely connected to the terminal of the instrument.
- Be sure to set the range selector switch to the OFF position after use. When the instrument will not be in use for a long period of time, place it in storage after removing the batteries.
- Do not expose the instrument to the direct sun, extreme temperature and humidity or dew fall.
- Use a damp cloth soaked in water or neutral detergent for cleaning the instrument. Do not use abrasives or solvents.
- When the instrument is wet, make sure to let it dry before putting it in storage.

2. Features

MODEL 4102 is an earth resistance tester for testing power distribution lines, in-house wiring system, electrical appliances etc. It also has an earth voltage range for earth voltage measurement.

- Designed to safety standard IEC 61557.
- Dust and drip proof construction in conformity with IEC 60529 (IP54). Measurement can be made even under adverse weather conditions.
- Simplified measurement probe has a structure that both the alligator clip and the test bar are available.
- OK lamp to check proper auxiliary earth resistance within tolerance and to recognize disconnection of test leads at a glance. Normal measuring conditions can be confirmed anytime.
- Convenient carrying soft bag for accessories etc.

3. Specifications

- Measuring Range and Accuracy (at $23\pm 5^{\circ}\text{C}$ and RH 75% or less)

Range	Measuring Range	Accuracy
Earth Voltage	0 - 30V	$\pm 3.0\%$ of full scale
Earth Resistance $\times 1\Omega$	0 - 12Ω	$\pm 3.0\%$ of full scale (Auxiliary earth resistance $100\Omega \pm 5\%$) (Earth voltage 10V or less)
$\times 10\Omega$	0 - 120Ω	
$\times 100\Omega$	0 - 1200Ω	

- Applicable Standards
 - IEC 61010-1 Overvoltage CAT III 300V Pollution Degree 2
 - IEC 61010-2-31
 - IEC 61557-1,5
 - IEC 60529 (IP54)
 - JIS C 1304-95

- Analog Meter
 - Self-shielding core magnet taut-band type

- Measuring Method

- Earth voltage measurement
 - Average sensing
- Earth resistance measurement
 - Constant current inverter
 - Frequency : Approx. 820Hz
 - Measuring current : x1Ω range Approx. AC 3mA
 - x10Ω range Approx. AC 2mA
 - x100Ω range Approx. AC 1mA

- Maximum Operating Error

Operating error (B) is an error obtained within the rated operating conditions, and calculated with the intrinsic error (A), which is an error of the instrument used, and the error (E_i) due to variations.

$$B = \pm(|A| + 1.15 \times \sqrt{(E_1^2 + E_2^2 + E_3^2 + E_4^2 + E_5^2 + E_7^2 + E_8^2)})$$

- A : Intrinsic error
- E₁ : Variation due to changing the position
- E₂ : Variation due to changing the supply voltage
- E₃ : Variation due to changing the temperature
- E₄ : Variation due to interference voltages
- E₅ : Variation due to earth electrode resistance
- E₇ : Variation due to changing the system frequency
- E₈ : Variation due to changing the system voltage

- Range to keep the maximum operating error

Measurement range within which the maximum operating error (±30%) applies.

- x1Ω range : 6-12Ω
- x10Ω range : 10-120Ω
- x100Ω range : 100-1200Ω

- Number of Measurement

- 10000 times or more
- (Measure 6Ω for 5s on x1Ω range and take a pause for 25s)

- Operating Temperature and Humidity
 - 0-40°C, relative humidity 85% or less (no condensation)
- Storage Temperature and Humidity
 - -20-60°C, relative humidity 85% or less (no condensation)
- Power Source
 - 9V DC : R6P (SUM-3) x6
- Overload Protection
 - Earth voltage and earth resistance ranges : 276V AC/DC (10 seconds)
- Insulation Resistance
 - 10MΩ or more at 1000V between the electrical circuit and the housing case
- Withstand Voltage
 - 3700V AC for one minute between the electrical circuit and the housing case
- Dimensions
 - 105(L) x 158(W) x 70(D) mm
- Weight
 - Approx. 600g
- Accessories

● M-7095	Test Leads	x 1 set
● M-8032	Auxiliary Earth Spikes	x 2
● M-7127	Simplified Measurement Probe	x 1 set
	(with safety alligator clip and flat test bar)	
● M-9084	Carrying Case	x 1
● Strap Belt		x 1
● Instruction Manual		x 1
● Battery R6P (SUM-3)		x 6
● Inspection Certificate (STD English only)		x 1

4. Layout Diagram

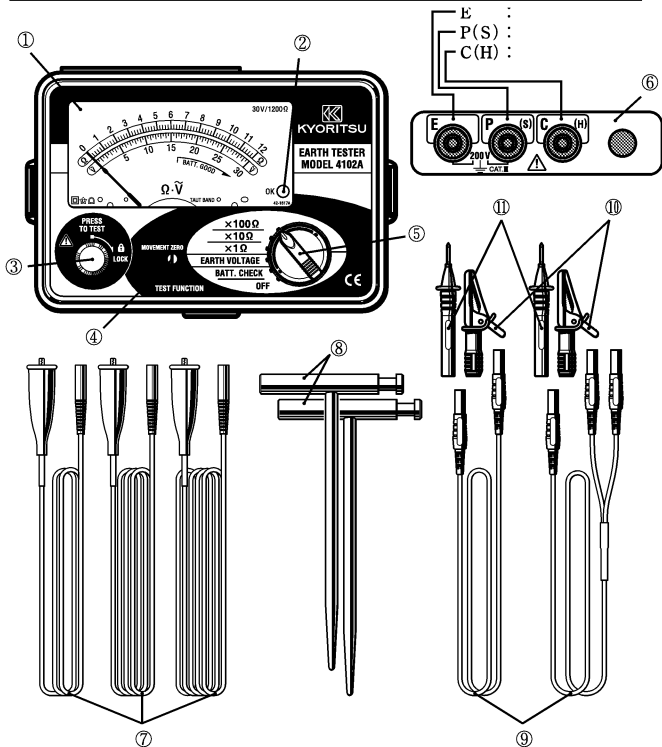

① Scale Board

③ Test Button

⑤ Range Selector Switch

⑦ Test Leads

⑨ Simplified Measurement Probe

⑪ Test Bar

② OK Lamp

④ Meter Zero Adjuster

⑥ Measuring Terminals

⑧ Auxiliary Earth Spikes

⑩ Safety Alligator Clip

5. Scale Reading

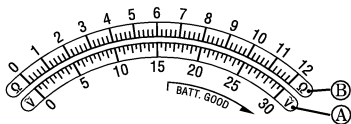

Range	Measuring Range	Scale		Scale Factor
Earth Voltage	0-30V	A	30	x 1
Earth Resistance	0-12 Ω	B	12	x 1
	0-120 Ω	B	12	x 10
	0-1200 Ω	B	12	x 100

6. Preparation for Measurement

6-1 Mechanical Zero Adjustment

To obtain a measurement value with high accuracy, rotate the meter zero adjuster by a driver etc. with the range selector switch OFF, and surely match the indicator to "0" graduation value at the left of the scale board.

6-2 Connecting Test Probe

Insert the plug of the probe securely into the terminals of the instrument. Loose connection may result in inaccurate measurements.

6-3 Battery Voltage Check

Set the range selector switch to BATT.CHECK position and press the test button. Then the indicator swings. Make sure that the indicator is at the right of BATT.GOOD graduation borderline on the scale board. Otherwise, the batteries are exhausted. Replace them according to section 8 for Battery Replacement.

7. Operating Instructions

⚠ DANGER

- The instrument will produce a maximum voltage of about 50V between terminals E-C or E-P in earth resistance function. Take enough caution to avoid electric shock hazard.
- When measuring earth voltage, do not apply voltage greater than 30V between measuring terminals.
- When measuring earth resistance, do not apply voltage between measuring terminals.

7-1 Principle of Measurement

This instrument makes earth resistance measurement with fall-of-potential method, which is a method to obtain earth resistance value R_x by applying AC constant current I between the measurement object E (earth electrode) and C (current electrode), and finding out the potential difference V between E and P (potential electrode).

$$R_x = V / I$$

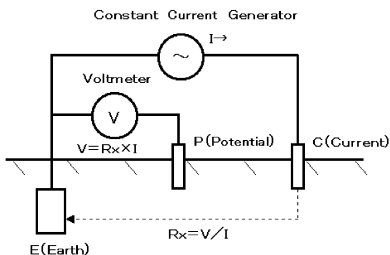

7-2 Precise Measurement (with Test Probe M-7095)

① Connection of Test Leads

Stick the auxiliary earth spikes P and C into the ground deeply. They should be aligned at an interval of 5-10m from the earthed equipment under test. Connect the green lead wire to the earthed equipment under test, the yellow wire to the auxiliary earth spike P and the red wire to the auxiliary earth spike C from terminals E, P and C of the instrument in order.

- Note :◇ Make sure to stick the auxiliary earth spikes in the moist part of the soil. Give enough water where the spikes have to be stuck into the dry, stony or sandy part of the earth so that it may become moist.
- ◇ In case of concrete, lay the auxiliary earth spike down and water it, or put a wet dustcloth etc. on the spike when making measurement.

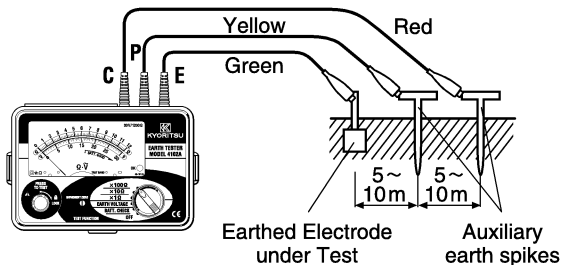

② Earth Voltage Measurement

Set the range switch to EARTH VOLTAGE position to check earth voltage in the condition of ① If the indicator swings, earth voltage exists. Make sure that the voltage is 10V or less.

When the display reads more than 10V, it may result in excessive errors in earth resistance measurement. To avoid this, make measurement after reducing the voltage by turning off the power supply of the equipment under test etc.

③ Precise Measurement

Set the range switch to $\times 100\Omega$ position and press the test button. LED remains illuminated during testing. Turn the range switch to $\times 10\Omega$ and $\times 1\Omega$ when the earth resistance is low. This indicated value is the earth resistance of the earthed equipment under test.

- Note : ◇ If the auxiliary earth resistance of auxiliary earth spike C is too high to make measurement, the indicator swings without LED lighting. Recheck the connection of test leads and the earth resistance of auxiliary earth spike.

⚠ DANGER

- When connecting the leads, make sure that they are separated. If measurement is made with the leads twisted or in touch with each other, the reading of the instrument may be affected by induction voltage.
- If earth resistance of auxiliary earth spikes is too large, it may result in inaccurate measurement.

Make sure to stick the auxiliary earth spike P and C into the moist part of the earth carefully, and ensure sufficient connections between the respective terminals and lead wires.

7-3 Simplified Measurement (with Test Probe M-7127)

Use this method when the auxiliary earth spike cannot be stuck. In this method, an existing earth electrode with a low earth resistance, such as a metal water pipe, a common earth of a commercial power supply and an earth terminal of a building, can be used with two-terminal method (E,P).

Use the simplified measurement probe attached which has a convenient structure that both the safety alligator clip and the test bar are available.

① Wiring

Make connection as shown in the figure.

Note : ◇ When the simplified measurement probes are not used, short P and C terminals.

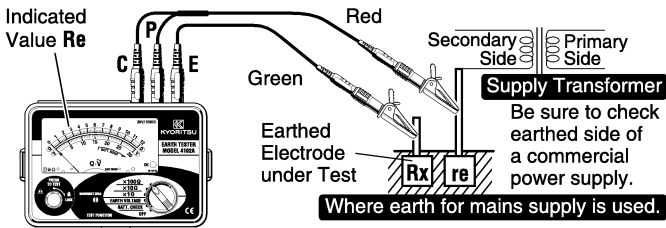

⚠ CAUTION

- Be sure to use the electroscope to check an earth of a commercial power supply.
- Do not use this instrument to check an earth of a commercial power supply. It is dangerous because the voltage may not be indicated even if it is live in case of disconnection of the earth electrode to be measured or wrong connection of test leads etc.
- Never attempt to measure commercial supply voltage with the instrument. It is not designed for the purpose. When using the simplified measurement probe MODEL 7127 attached, terminals P and Care short-circuited and the input impedance becomes small. Residual current circuit breaker may trip when the voltage is measured in the circuit with the breaker.

② Earth Voltage Measurement

Set the range switch to EARTH VOLTAGE position to check earth voltage in the condition of ①. If the indicator swings, earth voltage exists. Make sure that the voltage is 10V or less.

When the display reads more than 10V, it may result in excessive errors in earth resistance measurement. To avoid this, make measurement after reducing the voltage by turning off the power supply of the equipment under test etc.

③ Simplified Measurement

Set the range switch to $\times 100\Omega$ position and press the test button to make measurement. LED remains illuminated during testing. Turn the range switch to $\times 10\Omega$ and $\times 1\Omega$ when the earth resistance is low. This indicated value is the earth resistance of the earthed equipment under test.

Note : ◇ If the auxiliary earth resistance of auxiliary earth spike C is too high to make measurement, the indicator swings without LED lighting. Recheck the connection of test leads and the earth resistance of auxiliary earth spike.

④ Simplified Measurement Value

Two-terminal method is used for simplified measurement. In this method, earth resistance value r_e of earth electrode connected to terminal P is added to true earth resistance value R_x and shown as an indicated value R_e .

$$R_e = R_x + r_e$$

If the r_e is known beforehand, true earth resistance value R_x is calculated as follows.

$$R_x = R_e - r_e$$

8. Battery Replacement

⚠ DANGER

- Do not open the battery compartment cover, if the outer surface of the instrument is wet.
- Do not replace batteries while making measurement. To avoid shock hazard, turn the instrument off and disconnect the test leads and the probes from the instrument before opening the battery compartment cover.

⚠ CAUTION

- Do not mix new and old batteries.
- Install batteries in the orientation as shown inside the battery compartment, observing correct polarity.

- ① Turn off the instrument and disconnect the test leads and the probes from the terminals.
- ② Loosen two screws on the bottom of the instrument and remove the battery cover.
- ③ Always replace all six batteries in correct polarity.
Battery : R6P (AA dry battery) x6
- ④ Put the cover back in place and tighten the two screws.

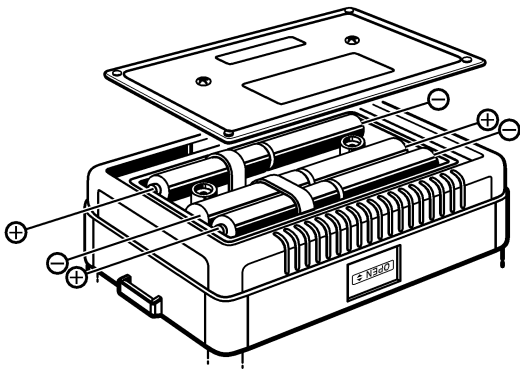

9. Notes on Housing Case & Accessories

9-1 Case Lid

Case lid can be fit under the housing case while making measurement.

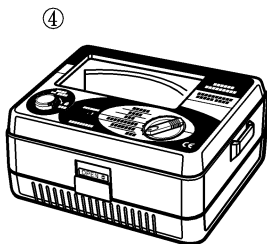
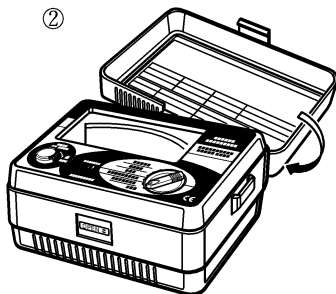
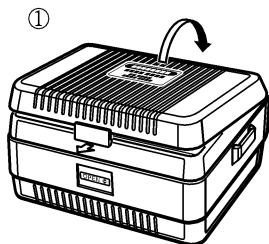

9-2 How to Fit Strap Belt

The instrument is equipped with a strap to suspend from the neck to allow both hands to be used freely for easy and safe operation.



10. Cleaning of Meter Cover

Antistatic additive has been applied to the meter cover of the instrument for electrification prevention, therefore, do not rub it strongly with a dry cloth etc. even if it is dirty. Should it become old and charged with electricity, wipe the cover with a cloth soaked in the commercial detergent with antistatic additive.

Memo

Memo

DISTRIBUTOR

Kyoritsu reserves the rights to change specifications or designs described in this manual without notice and without obligations.



®

**KYORITSU ELECTRICAL INSTRUMENTS
WORKS, LTD.**

No.5-20,Nakane 2-chome, Meguro-ku,

Tokyo 152-0031 Japan

Phone : (03) 3723-0131

Fax : (03) 3723-0152

URL : <http://www.kew-ltd.co.jp>

E-mail : info@kew-ltd.co.jp

Factories : Uwajima & Ehime